

DESIGN CHANGES
 * Reduced length of crank (part 5).
 * Reduced length of piston (part 4).
 * Both reductions improve cost by reducing material used, and do not alter function.

18	0C00014A	1
17	0C00012A	1
16	0C00011A	1
15	0C00010A	1
14	93985A206	1
13	6391K616	1
12	5463K422	1
11	B4X9X4	2
10	57445K21	1
9	0C00009A	1
8	0C00005A	1
7	0C00008A	1
6	0C00007A	1
5	0C00006A	1
4	0C00004A	1
3	0C00003A	1
2	0C00002B	1
1	95495K818	3
PC NO	PART NAME	QTY

ALL DIMENSIONS IN INCHES

		UNIVERSITY OF ROCHESTER		
FIRST ISSUED	3/19/21	TITLE		
DRAWN BY	INSKIP			
MATERIAL		AIR ENGINE		
FINISH	NONE			
REVIEWED BY		SIZE	DRG NO.	SHEET REV
		B	0c00001A	A
		SCALE 1:1	SHEET 1 OF 10	

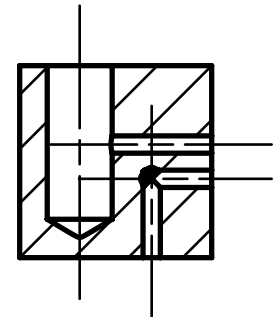
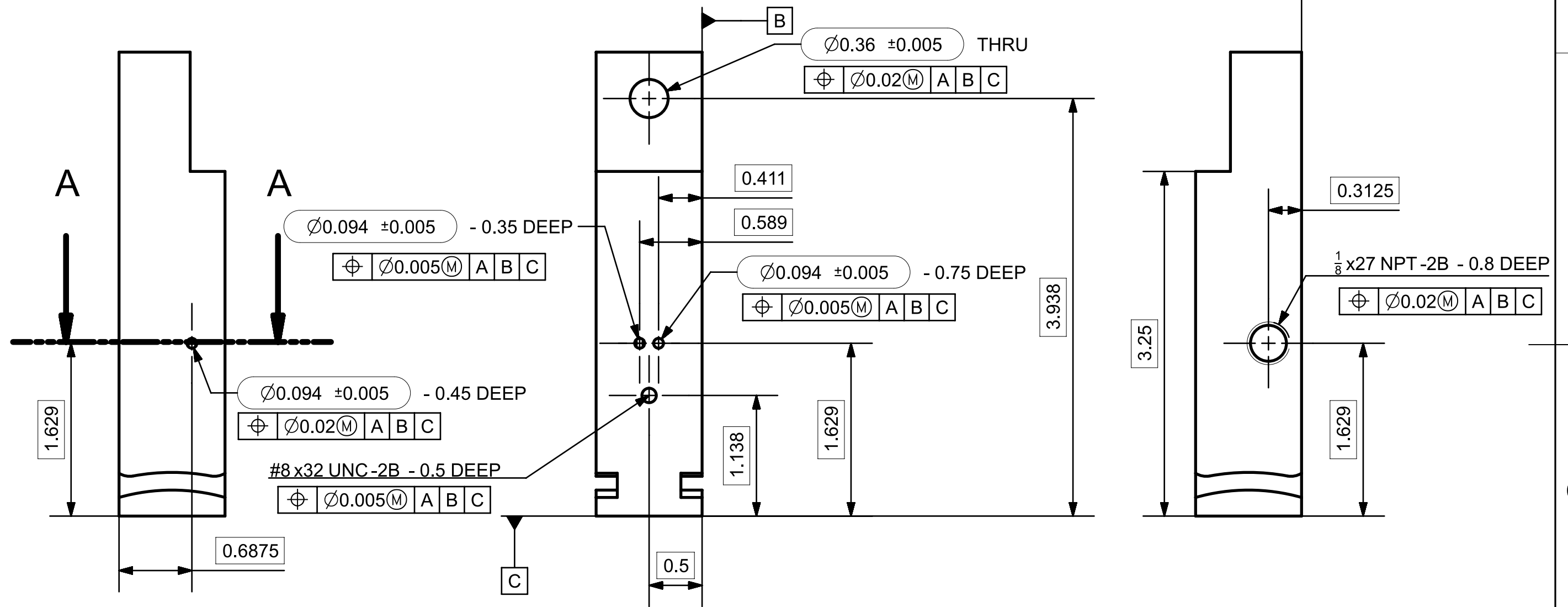
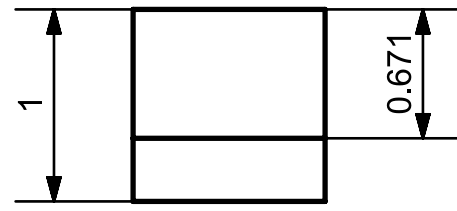
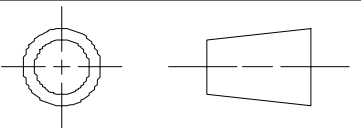

SECTION A-A

UNLESS OTHERWISE SPECIFIED

ANGLES ± 0.5°	X ± 0.025	X.X ± 0.020	X.XX ± 0.010	X.XXX ± 0.005	X.XXXX ± 0.0005
------------------	--------------	----------------	-----------------	------------------	--------------------

ALL DIMENSIONS IN INCHES



UNIVERSITY OF ROCHESTER

FIRST ISSUED	3/19/21	TITLE		
DRAWN BY	INSKIP	CYLINDER		
MATERIAL	ALUMINUM			
FINISH	NONE	SIZE	DRG NO.	SHEET REV
REVIEWED BY		B	0c00002B	A
		SCALE 1:1	SHEET 2 OF 10	

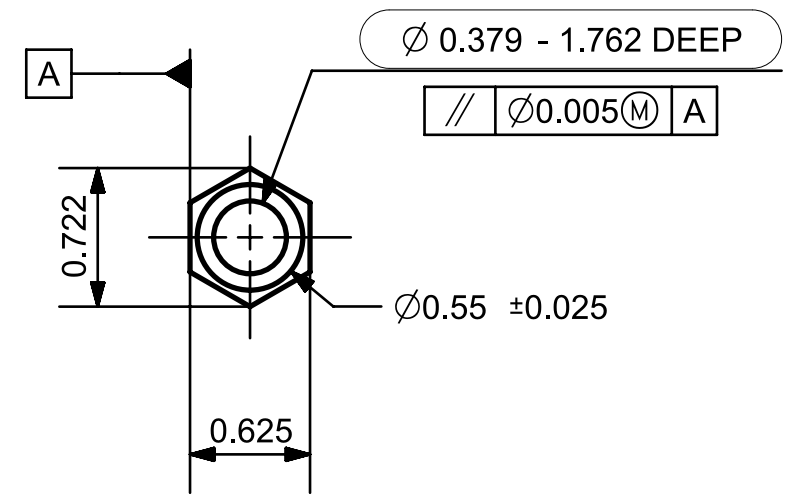
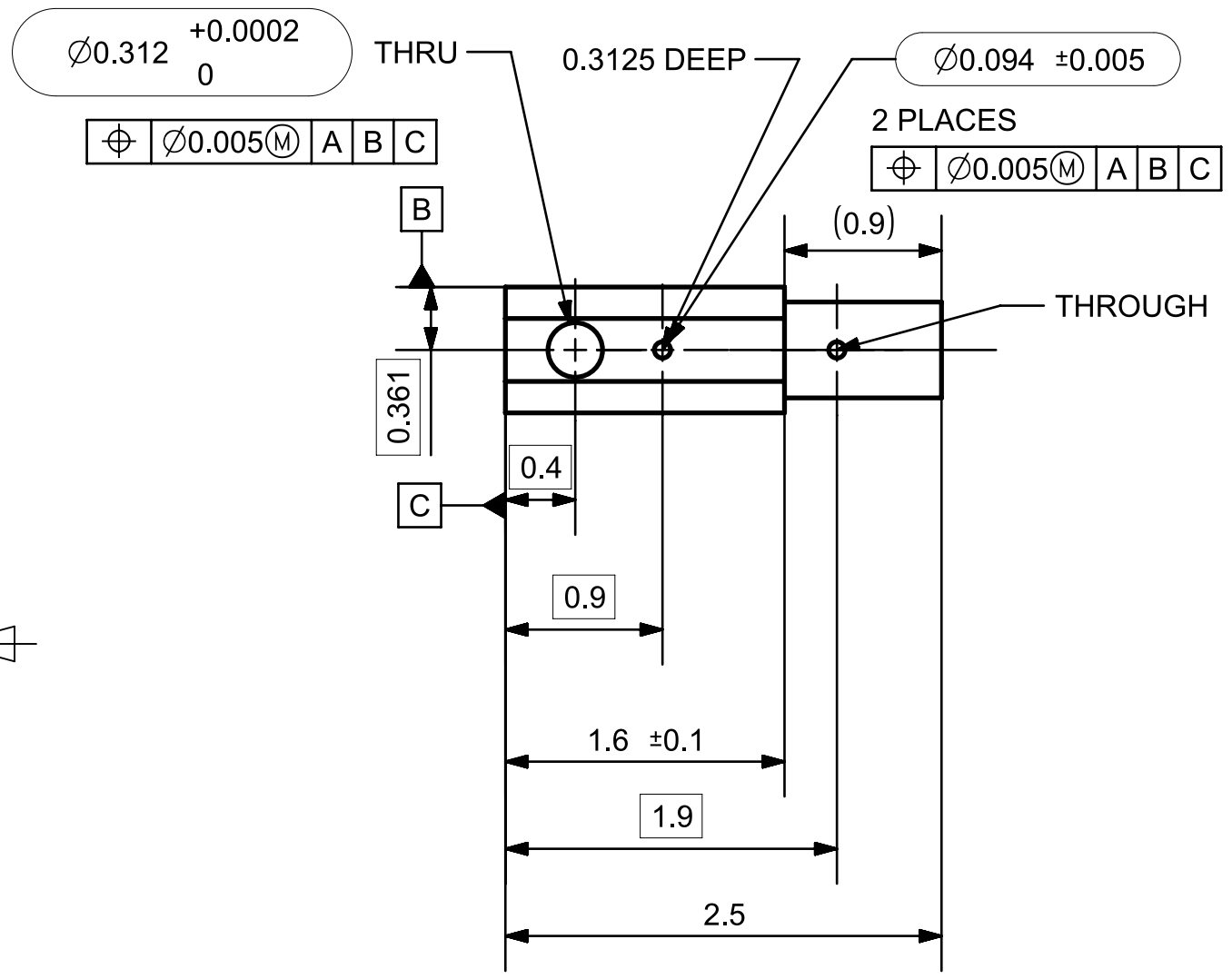
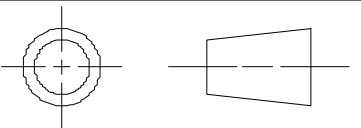

UNLESS OTHERWISE SPECIFIED

ANGLES	X	X.X	X.XX	X.XXX	X.XXXX
± 0.5°	± 0.025	± 0.020	± 0.010	± 0.005	± 0.0005

ALL DIMENSIONS IN INCHES



UNIVERSITY OF ROCHESTER

FIRST ISSUED	3/19/21	TITLE		
DRAWN BY	INSKIP	CYLINDER		
MATERIAL	ALUMINUM			
FINISH	NONE	SIZE	DRG NO.	SHEET REV
REVIEWED BY		B	0c00003A	A
		SCALE 1:1	SHEET 3 OF 10	

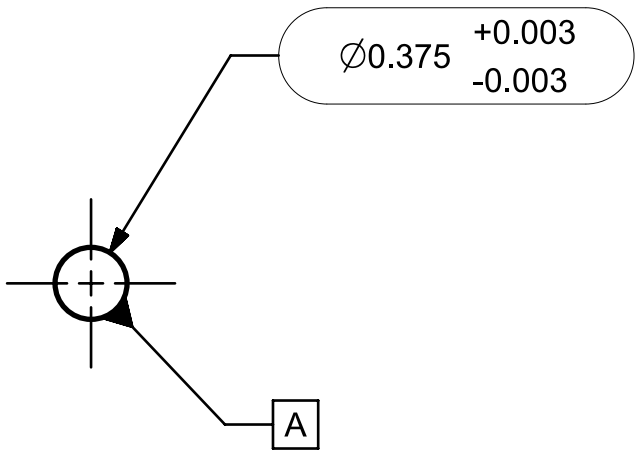
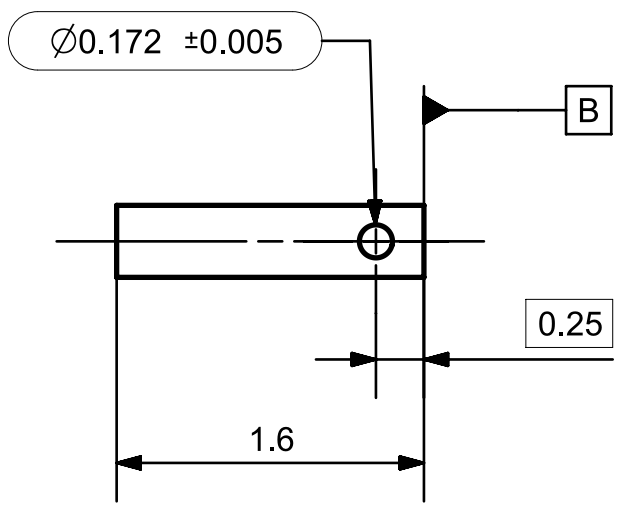
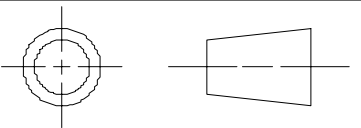

UNLESS OTHERWISE SPECIFIED

ANGLES ± 0.5°	X ± 0.025	X.X ± 0.020	X.XX ± 0.010	X.XXX ± 0.005	X.XXXX ± 0.0005
------------------	--------------	----------------	-----------------	------------------	--------------------

ALL DIMENSIONS IN INCHES



UNIVERSITY OF ROCHESTER

FIRST ISSUED	3/19/21	TITLE			
DRAWN BY	INSKIP	PISTON			
MATERIAL	BRASS				
FINISH	NONE	SIZE	DRG NO.	SHEET REV	
REVIEWED BY		B	0c00004A	A	
SCALE 1:1			SHEET 4 OF 10		

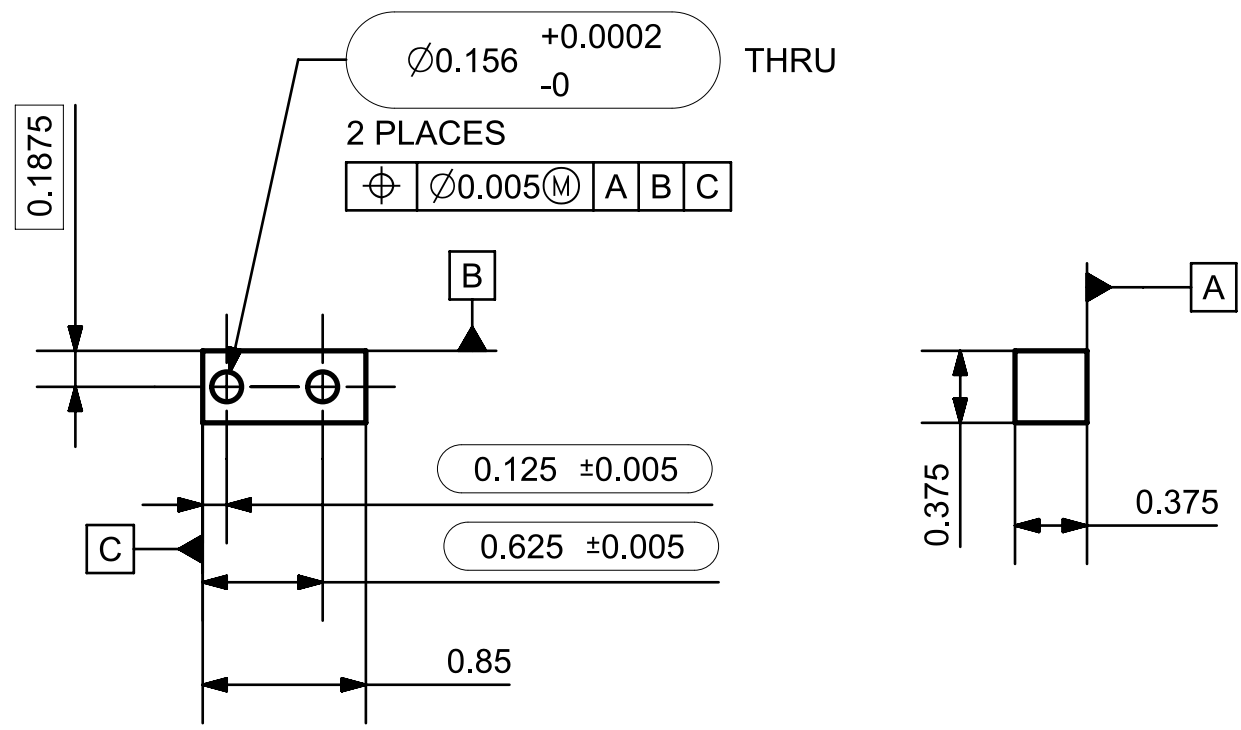
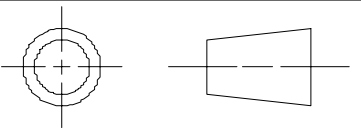

UNLESS OTHERWISE SPECIFIED

ANGLES	X	X.X	X.XX	X.XXX	X.XXXX
$\pm 0.5^\circ$	± 0.025	± 0.020	± 0.010	± 0.005	± 0.0005

ALL DIMENSIONS IN INCHES



UNIVERSITY OF ROCHESTER

FIRST ISSUED	3/19/21	TITLE		
DRAWN BY	INSKIP	CRANK		
MATERIAL	STEEL			
FINISH	NONE	SIZE	DRG NO.	SHEET REV
REVIEWED BY		B	0c00006A	A
		SCALE 1:1	SHEET 5 OF 10	

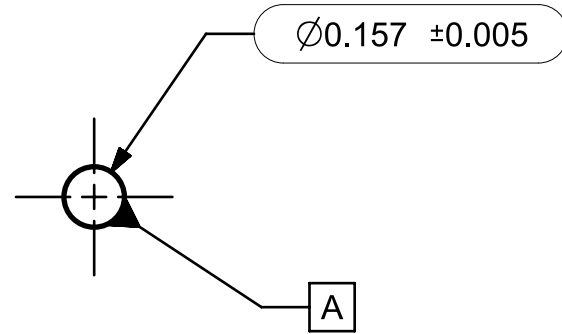
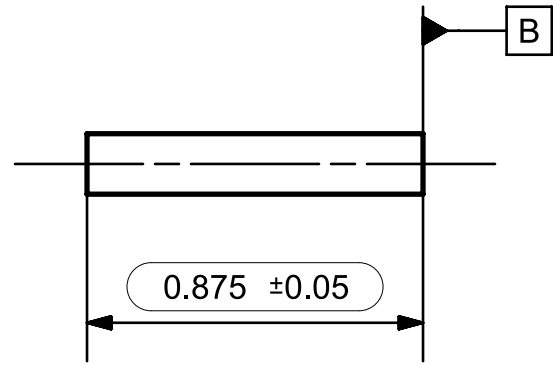
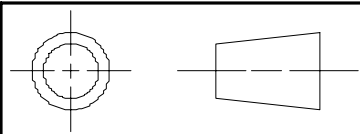

UNLESS OTHERWISE SPECIFIED

ANGLES ± 0.5°	X ± 0.025	X.X ± 0.020	X.XX ± 0.010	X.XXX ± 0.005	X.XXXX ± 0.0005
------------------	--------------	----------------	-----------------	------------------	--------------------

ALL DIMENSIONS IN INCHES



UNIVERSITY OF ROCHESTER

FIRST ISSUED	3/19/21	TITLE			
DRAWN BY	INSKIP	CRANK-PISTON PIN			
MATERIAL	STEEL				
FINISH	NONE				
REVIEWED BY		SIZE	DRG NO.	SHEET REV	
		B	0c00007A	A	
SCALE 2:1			SHEET 6 OF 10		

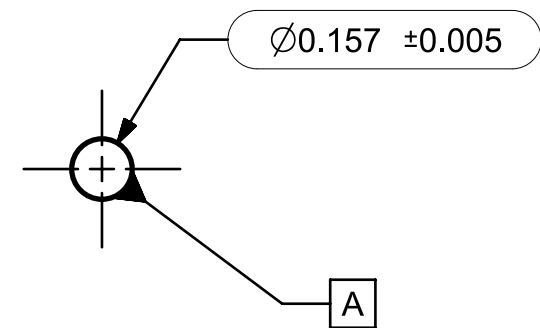
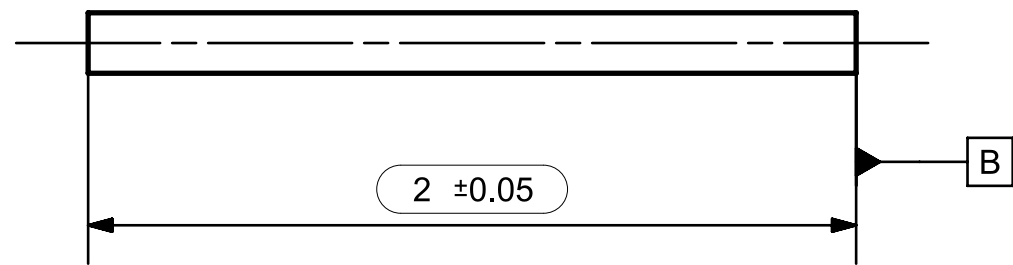
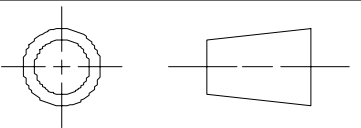

ALL DIMENSIONS IN INCHES



UNIVERSITY OF ROCHESTER

FIRST ISSUED	3/19/21	TITLE CRANK-FLYWHEEL PIN		
DRAWN BY	INSKIP			
MATERIAL	STEEL			
FINISH	NONE			
REVIEWED BY		SIZE	DRG NO.	SHEET REV
		B	0c00008A	A
		SCALE 2:1	SHEET 7 OF 10	

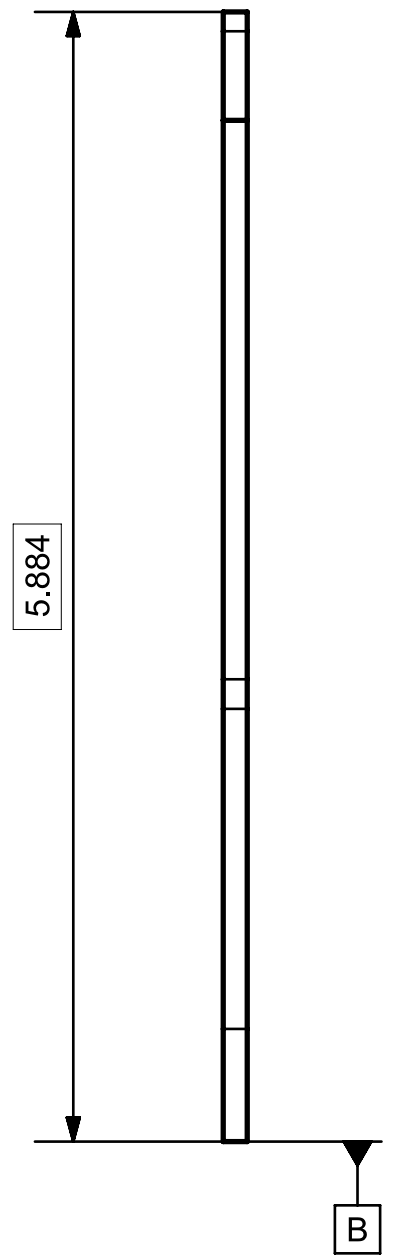
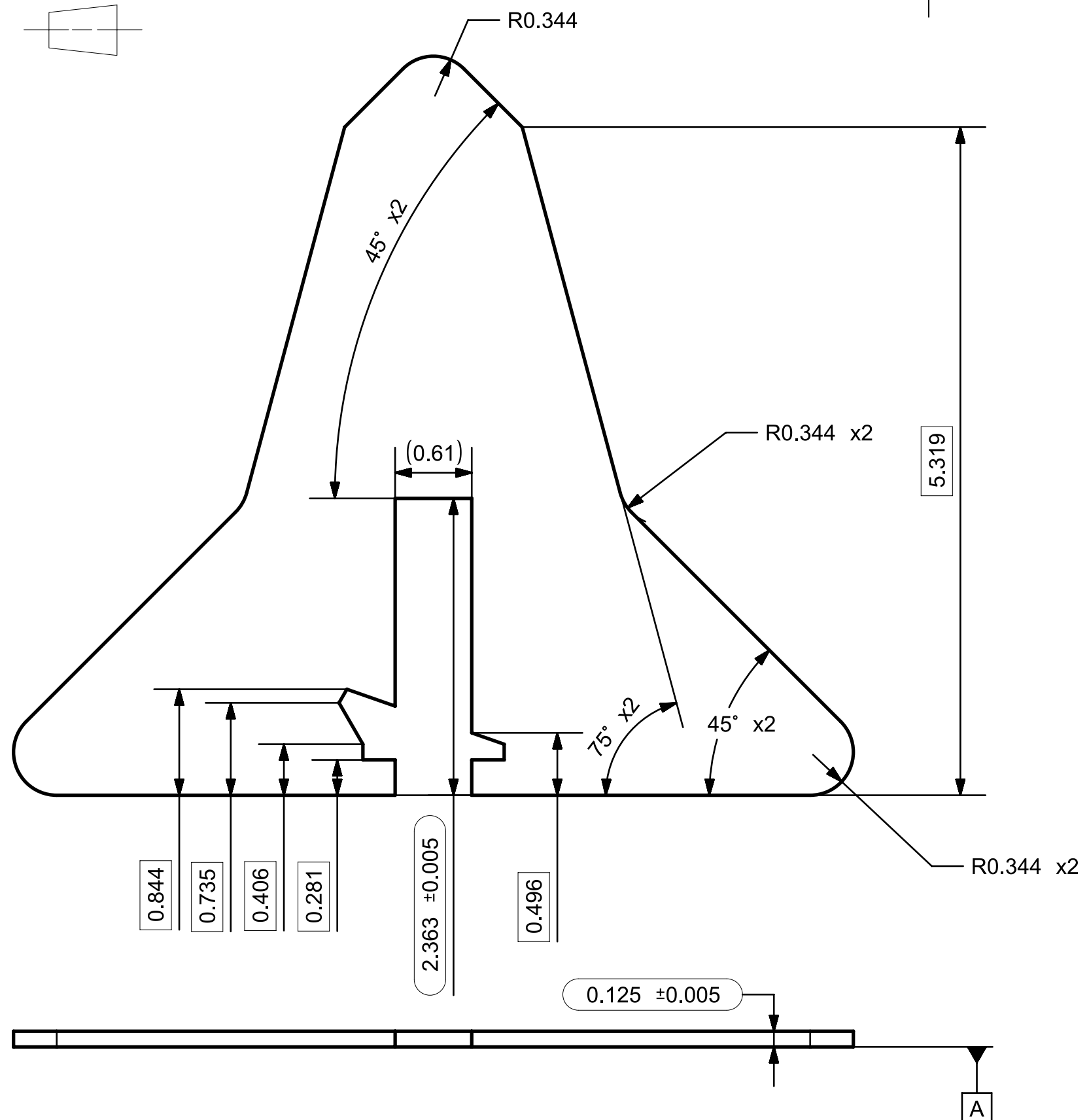
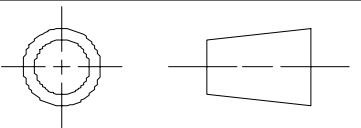

UNLESS OTHERWISE SPECIFIED

ANGLES ± 0.5°	X ± 0.025	X.X ± 0.020	X.XX ± 0.010	X.XXX ± 0.005	X.XXXX ± 0.0005
------------------	--------------	----------------	-----------------	------------------	--------------------

ALL DIMENSIONS IN INCHES

		UNIVERSITY OF ROCHESTER		
		TITLE		
FIRST ISSUED	3/19/21	BASE_MAIN		
DRAWN BY	INSKIP			
MATERIAL	BALTIC BIRCH	SIZE	DRG NO.	SHEET REV
FINISH	NONE			
REVIEWED BY		SCALE 1:1		SHEET 8 OF 10

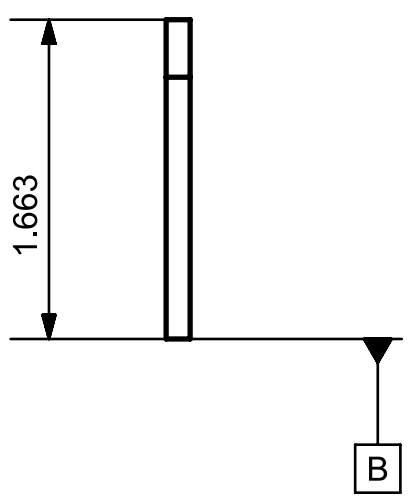
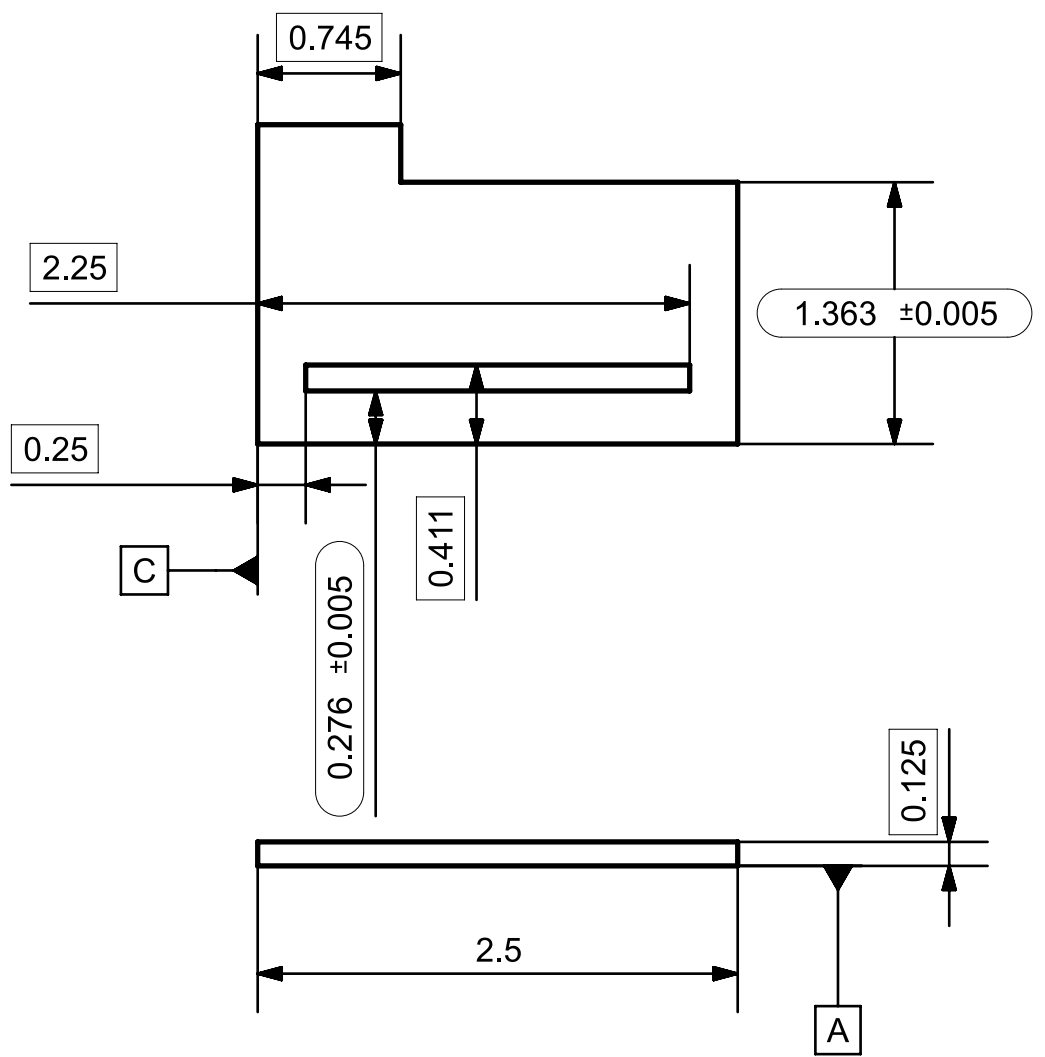
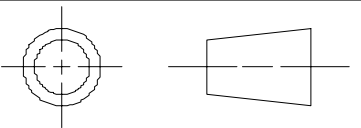

UNLESS OTHERWISE SPECIFIED

ANGLES ± 0.5°	X ± 0.025	X.X ± 0.020	X.XX ± 0.010	X.XXX ± 0.005	X.XXXX ± 0.0005
------------------	--------------	----------------	-----------------	------------------	--------------------

ALL DIMENSIONS IN INCHES



UNIVERSITY OF ROCHESTER

FIRST ISSUED	3/19/21	TITLE		
DRAWN BY	INSKIP	BASE_BACKBONE		
MATERIAL	BALTIC BIRCH			
FINISH	NONE	SIZE	DRG NO.	SHEET REV
REVIEWED BY		B	0c00011A	A
		SCALE 1:1	SHEET 9 OF 10	

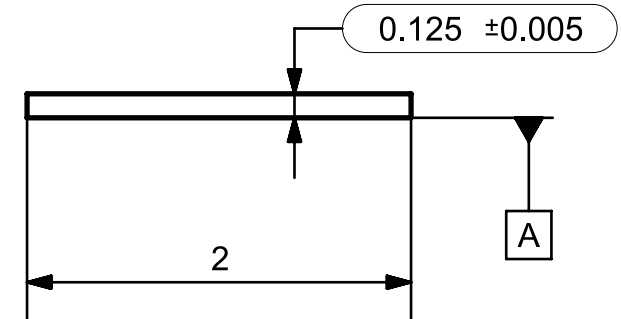
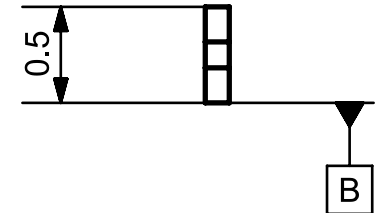
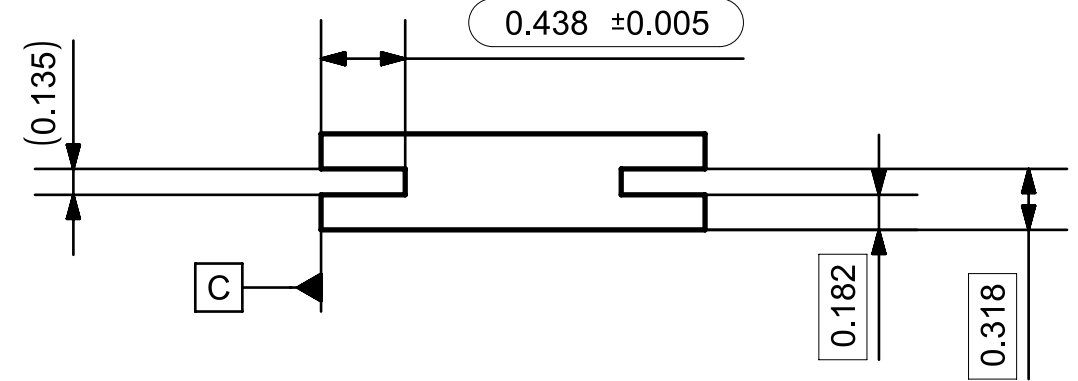
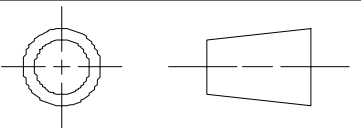

UNLESS OTHERWISE SPECIFIED

ANGLES ± 0.5°	X ± 0.025	X.X ± 0.020	X.XX ± 0.010	X.XXX ± 0.005	X.XXXX ± 0.0005
------------------	--------------	----------------	-----------------	------------------	--------------------

ALL DIMENSIONS IN INCHES



UNIVERSITY OF ROCHESTER

FIRST ISSUED	3/19/21	TITLE		
DRAWN BY	INSKIP	BASE_LOCKING		
MATERIAL	BALTIC BIRCH			
FINISH	NONE	SIZE	DRG NO.	SHEET REV
REVIEWED BY		B	0c00012A	A
		SCALE 1:1	SHEET 10 OF 10	